







THE GCDuino² PINOUT DIAGRAM

Programmer Connection

-  Components face up When plugged in
-  Uses Serial Rx & Tx Pins

LEGEND

Ground
Power
Port Address
Digital Pin
Analog Pin
Pin Change INT
Communication
Control
Pin Function
PWM
Special

-  IMPORTANT
-  INFORMATION

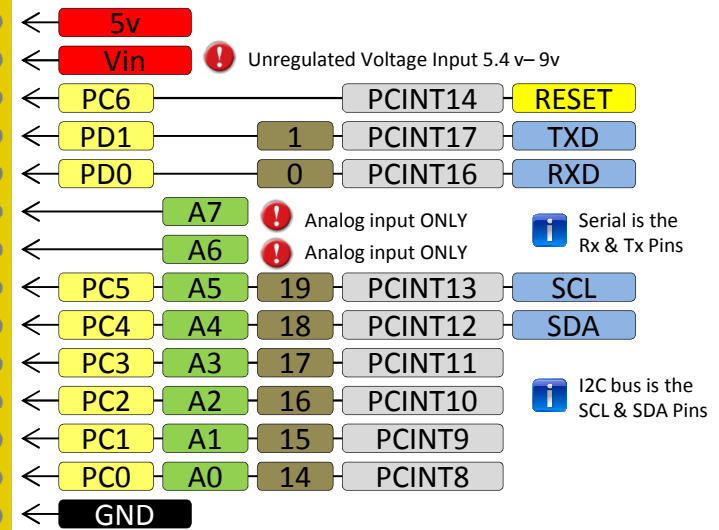
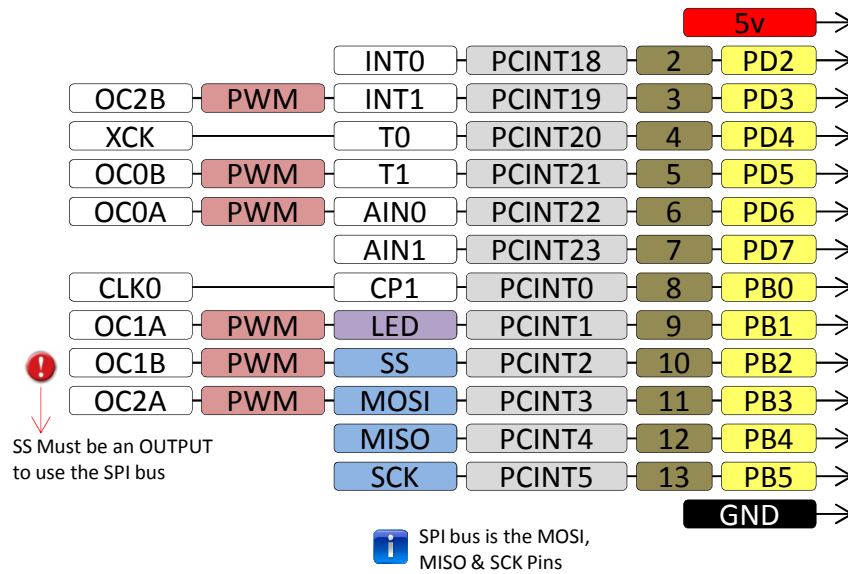
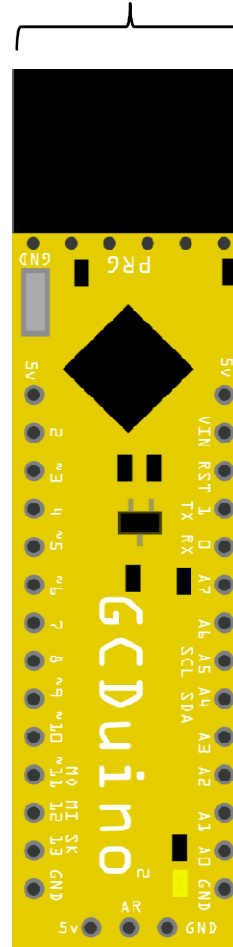

 SS Must be an OUTPUT to use the SPI bus

 SPI bus is the MOSI, MISO & SCK Pins

 Serial is the Rx & Tx Pins

 I2C bus is the SCL & SDA Pins

